

NX for Mechanical Design

Transforming product development by delivering greater power, speed, quality, productivity and efficiency for mechanical design

fact sheet

Siemens PLM Software

www.siemens.com/plm

► Summary

The NX™ software for mechanical design provides a comprehensive set of leading-edge CAD modeling tools that enable companies to design higher quality products faster and less expensively. NX's comprehensive mechanical design solution lets you choose the tools and methodologies that best suit your design challenge. Innovative technologies deliver breakthrough mechanical design capabilities that set new standards for speed, performance and ease-of-use.

Benefits

Facilitates design control, speeds the design process, increases designer and design team productivity and improves design throughput

Improves design team performance, especially for handling large, complex models

Raises product quality by minimizing design errors

Produces faster, more accurate and complete product documentation

Produces significant time, effort and cost savings by facilitating design re-use

Facilitates better integration and coordination between multiple design disciplines, design teams and their related CAD systems

NX's mechanical design capabilities are unmatched in terms of the power, versatility, flexibility and productivity they deliver to your digital product development environment. NX enables you to establish a complete design solution for your environment, including leading-edge tools and methodologies for:

- Comprehensive high-performance modeling, which enables you to seamlessly use the most productive modeling approaches – from explicit solid and surface modeling to parametric, process-specific and history-free direct modeling that works with models from any CAD system.
- Active mockup and assembly design, which enables you to work interactively with massive multi-CAD assemblies while leveraging leading assembly management and engineering tools.
- Standards-compliant drafting and 3D annotation, which streamlines the creation of product documentation by directly leveraging your 3D master model.

Today's mechanical design challenges

Manufacturing companies are driven by an increased pressure to develop more innovative products in a shorter time frame while continuing to deliver high levels of quality. Even with mature 3D CAD technology, many companies fail to significantly reduce process waste, improve product quality or deliver breakthrough product innovations that stir the imagination of the marketplace.

These challenges require a radical rethinking of the business model that pertains to product development. This rethinking should begin with transforming the design process. Product design fuels the entire development effort. Today's design processes involve increasingly complex products comprised of design elements created by multiple teams, disciplines and suppliers using independent CAD systems. These complex processes require product makers to coordinate the activities of team members dispersed across different geographies while retaining design intent from the start of the design project to its completion.

Companies need design processes that compress the design cycle by eliminating value-added tasks, maximizing knowledge re-use and proactively addressing manufacturability issues before they reach the factory floor. Product developers need to “design-in” rather than “inspect-in” product quality.

Features

Comprehensive 3D design capabilities, including wireframe, surface, solid and direct modeling

Synchronous Technology for uniting parametric and history-free modeling in the same design environment

Assembly modeling with full-context, multi-CAD digital mockup and validation tools

Interactive design of massive assemblies that improves the performance and capacity of your design environment

Process-specific, streamlined modeling tools for sheet metal routed systems and other applications

Configurable, intuitive interface that facilitates ease-of-use, user learning and accessibility to powerful modeling capabilities

Associative integration with all NX product development solutions, including NX's industrial design, electromechanical, simulation, tooling and machining solutions

Automated, real-time design validation checking to monitor functional requirements

Knowledge capture and automation tools

Seamlessly integrated, transparent engineering data and process management

NX's next-generation design solutions

NX delivers next-generation design solutions that transform the entire product development cycle. NX represents a radical departure from conventional CAD systems. NX improves speed and efficiency while eliminating wasted work by providing unique technologies and methodologies, including:

Knowledge-enabled design. NX automates and simplifies design by enabling you to leverage the product and process knowledge that your company has gained from its experiences as well as from industry best practices. NX tools enable designers to capture knowledge in the form of high-level product structure, templates, frequently used design features, engineering rules, formulae and validation checks. Knowledge-enabled design helps your company reduce design costs, compress the design cycle and improve design quality.

You can manage your entire design process with Siemens' Teamcenter® software, which lets you establish and seamlessly integrate a single source of product and process knowledge into your design environment. This enables you to coordinate your design chain, standardize your design processes and accelerate decision making throughout the design cycle.

Process innovation. NX enables you to establish an interactive environment where everyday design work can be streamlined through the implementation of task-oriented workflows that improve designer productivity. NX design environments facilitate high-performance modeling techniques that provide design teams with the flexibility and power to handle design of virtually any size or complexity. NX allows you to dynamically integrate your CAD processes with planning, simulation, tooling, manufacturing and other lifecycle processes and make informed design decisions by recognizing the requirements of all design stakeholders and coordinating their activity.

More specifically, NX addresses the mechanical design process directly through its capabilities for:

- Comprehensive high-performance modeling
- Active mockup and assembly design
- Standards-compliant drafting and 3D annotation

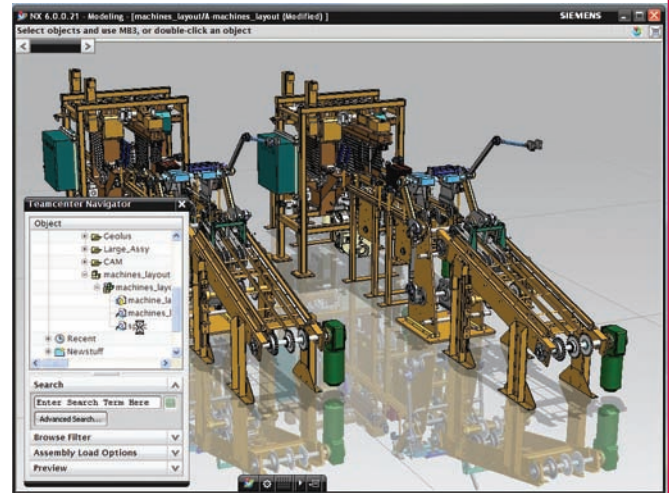

NX seamlessly integrates Teamcenter-managed engineering and process data, enabling designers to quickly search a single source of knowledge and locate the information they need to use

Comprehensive high-performance modeling

NX delivers the most powerful and flexible modeling solutions available – solutions that enable you to freely use any modeling technique that fits your design challenge. All NX modeling tools are built on Siemens' Parasolid® geometry modeling kernel, the world's most powerful, robust and widely used modeling foundation.

Design Freedom. NX supports Design Freedom powered by Siemens' groundbreaking Synchronous Technology. This unique approach enables you to unite feature-based parametric and history-free modeling in the same design environment.

Design Freedom means that your designers can use NX's synchronous modeling tools to modify design geometry initially created on other CAD systems or by other modeling techniques. It does not matter whether the data in question was imported from another CAD system or whether is native parametric or non-parametric. NX synchronous tools enable designers to work directly with any geometry without the need to rebuild data. These synchronous tools let designers use parametric features without the limitations of a feature history.

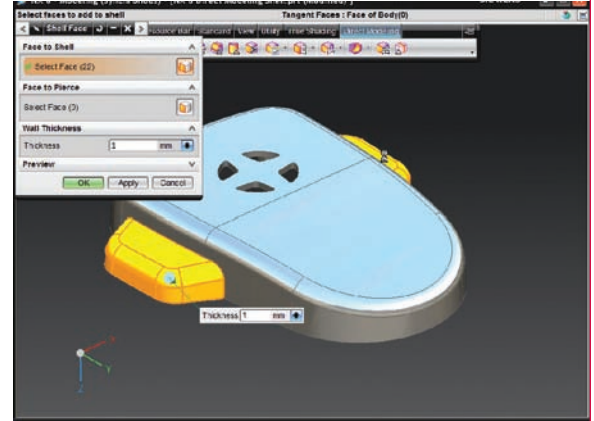

NX Synchronous Technology enables designers to perform history-free editing on imported CAD models

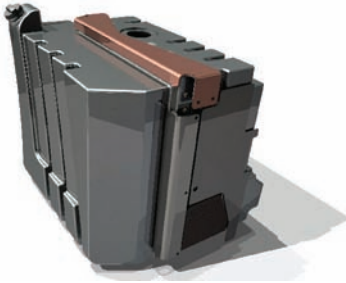

Sheet metal design is one of several streamlined process-specific modeling tools provided by NX

Process-specific modeling. Conventional CAD systems leave it up to the designer to figure out how to apply a system's various tools. In contrast, NX logically structures commands in workflows oriented to accomplishing specific design tasks. NX is prepackaged with industry roles that tailor the user interface and incorporate best practice guidelines. NX also delivers process-based tools that build in domain expertise for meeting specific challenges (such as dealing with sheet metal components) or for performing industry-specific processes (such as handling automotive body structures and general packaging). Process-specific design aids enable designers to work faster than general purpose CAD tools.

Design re-use. Design re-use becomes increasingly more important as today's manufacturers try to expand their market share by establishing product platforms. NX lets you use any part or assembly as a template for new designs, building product knowledge and best practices into your development processes. This capability supports your commonization, modularization and re-use initiatives by enabling you to reduce design time by up to 80 percent.

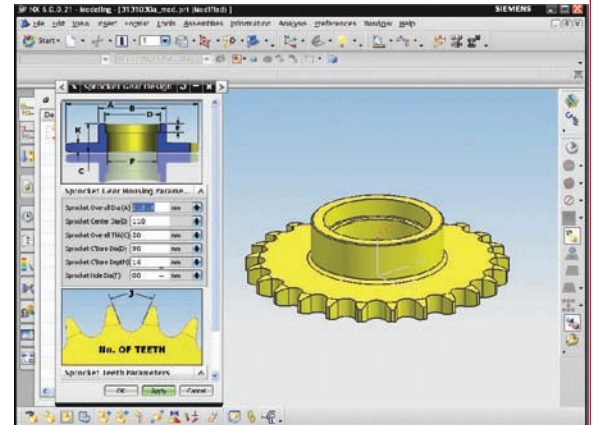

NX knowledge-enabled design tools let companies re-use existing designs as customized templates for new designs

Active mockup and assembly design

NX's powerful mockup and assembly capabilities provide your design environment with a variety of interactive capabilities that expedite your assembly design and engineering processes.

Active Mockup. NX Active Mockup enables your designers to easily navigate large assemblies and establish an appropriate environment for detailed work on sub-assemblies and components. Active Mockup utilizes industry-standard JT technology to enable designers to load thousands of components from multiple CAD systems in just seconds. JT is a highly flexible CAD neutral format that allows designers to fully represent all relevant model information. The JT format can be created from most major CAD applications. Depending on your type of business process, JT data can be very lightweight or very rich. JT models are able to hold precise model geometry, product structures, attributes and PMI, including geometric data, translations and annotations. JT enables you to load assemblies with up to a million parts with exceptional interactive performance.

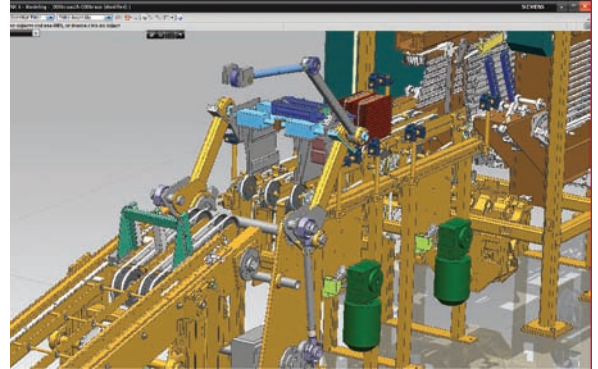

NX Active Mockup and assembly management enables collaborative design to be performed in the full context of complex assemblies

As a result, Active Mockup provides designers with a true interactive design capability that lets them rapidly display, section and rotate very large assemblies. Active Mockup enables design teams to collaborate by viewing, modifying and evaluating complete digital mockups. Teams can view as much of the product design as required to evaluate its parts in the context of a particular task. These design-in-context capabilities facilitate rapid problem resolution during the physical assembly process.

Assembly design validation. NX provides validation tools that enable your designers to identify and resolve assembly design and process problems in the early stages of development – without resorting to physical prototyping. NX enables designers to perform interactive clearance checking and interference checking to detect and eliminate fit problems. Designers can interactively simulate assembly motion to check and optimize moving components.

With automated assembly path planning and motion envelopes, designers can optimize products for assembly, disassembly, maintenance and service. Designers can record and play back assembly and motion sequences as movies that can be shared as assembly instructions with the factory floor. These simple to use tools can be leveraged to quickly validate design changes as the product evolves.

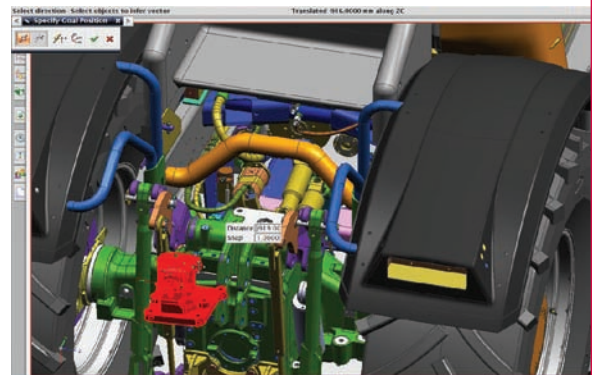

NX assembly validation tools include extraction path planning capabilities that optimize designs so that a product can be easily assembled, disassembled and maintained

Routed systems design. NX provides tools that enable designers to create and validate routed subsystems for both mechanical and electrical designs. Mechanical routing tools and libraries are available for tubing, piping and steelwork. Electrical routing tools enable designers to place wiring, conduit and raceways while standard component libraries are available for electrical systems. NX electrical routing includes wire harness design and manufacturing support, eliminating the need for physical prototype and reducing product development time by allowing designers to perform interface checks, validate design rules, visualize the routing pattern in 3D and trace the location of specific wires and connections.

NX maintains associative links between the P&ID layout and the 3D systems to ensure that system logic is maintained. Designers can quickly apply logical design changes to the routed system. Routed systems are fully associative to NX assemblies to facilitate design changes. Automated bill of material and other reporting provide information for subsystem manufacturing.

Standards-compliant drafting and 3D annotation

NX delivers production-driven tools for documenting your designs either as standards-compliant 2D drawings or 3D product and manufacturing information (PMI) annotations. You can use these capabilities to ensure that design intent is properly communicated throughout your development organization. They improve product quality by removing potential sources of interpretation error from your design environment and by speeding the process you use to take your designs to manufacturing.

NX drafting capabilities enable designers to rapidly lay out their drawings, as well as to create drawing views, detailing and dimensioning and geometric dimensioning and tolerancing (GD&T). Since NX adheres to the industry standards for PMI 3D model annotation, the dimensions, symbols and tolerances can be automatically inherited on drawing views and directly used by downstream analysis and manufacturing applications. This improves productivity by eliminating the need to re-enter this information.

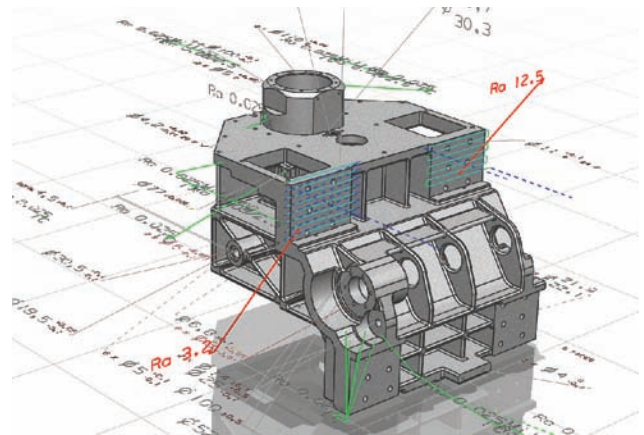

Designers can use NX to directly include complete PMI on a 3D design model, thereby improving communications and accelerating downstream applications

► Contact

Siemens PLM Software

Americas 800 498 5351

Europe 44 (0) 1276 702000

Asia-Pacific 852 2230 3333

www.siemens.com/plm

SIEMENS